

Article number: 057125137762

Description: Hepco GV3 slide NMS E L3776 P2
with counterbored holes

Measures

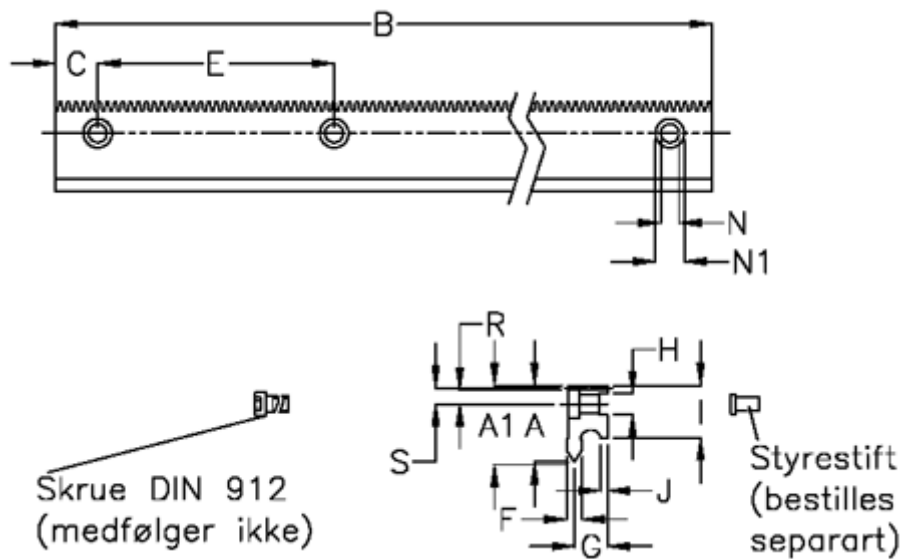

A	= 11	G	= 6.4	Side power N at I2 = 3.5
A1	= 11.19	H	= 4	Tooth size = 0.50
B	= 3776	I	= 9.25	Weight kg/1000 = 0.55
C	= 20.5	J	= 1.70	
E	= 45	N1	= 6.2 x 3.1	
F	= 3.20	Precision type = P2		
For bearing	= J13	R	= 3.80	
For guide pin	= SDP4	S	= 4.50	